

ScaraBot Endurance

In the Box

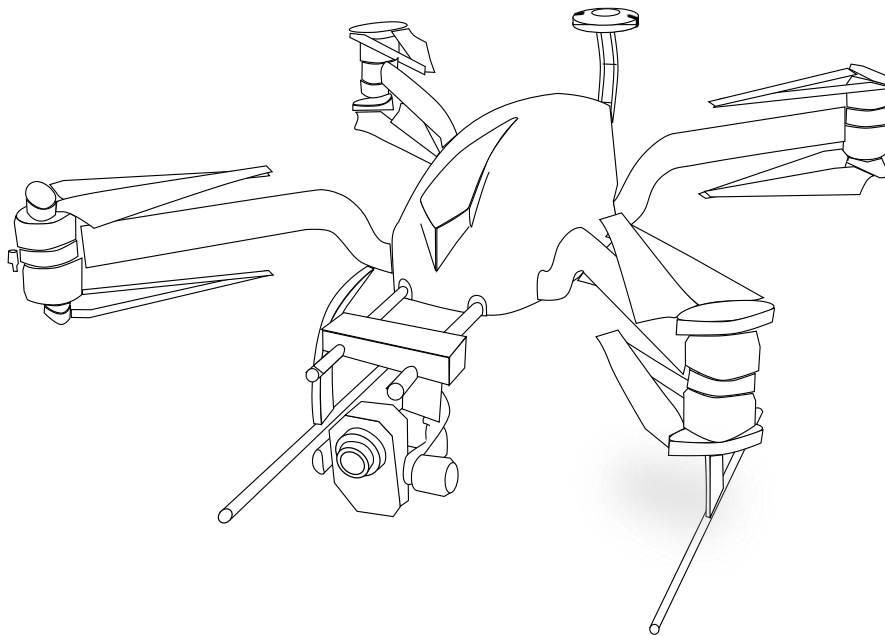

ScaraBot Technologies GmbH

Release 0.0.2, March 10,2020

Important!

Check that all the following items are included in your delivered project. In case any item is missing, please contact to ScaraBot Technologies.

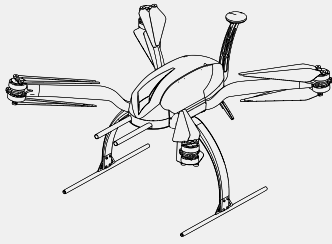

ScaraBot Copter system

ScaraBot Endurance aircraft body.

Extras:

- Droniq BLOS Device
- RTK GPS Receiver

x 1

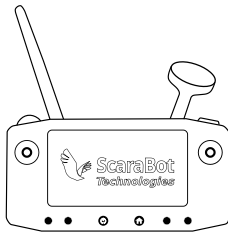

ScaraBot Remote Control

Base Station for ScaraBot Endurance

- Control
- Telemetry
- Video link if available from Payload

x 1

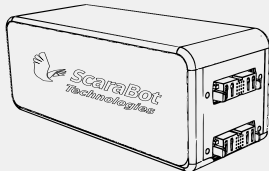

ScaraBot Smart Battery

Dual Redundancy Smart Battery

- SMBUS Protocol
- Charge status: LED display

x 3

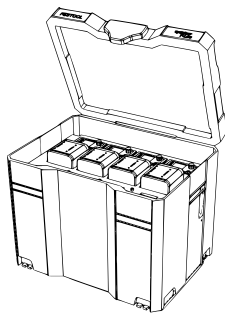

ScaraBot Smart Battery Charger

Smart Battery Charger for ScaraBot Endurance Dual Smart Batteries exclusive.

x 1

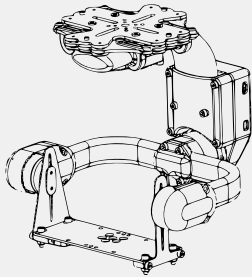

ScaraBot BLG400 Gimbal

BLG 400 with Payload integrated.

Extras:

- Micasense Altum
- DLS2 Light Sensor

x 1

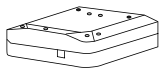
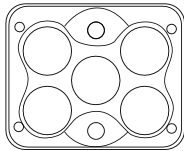

Micasense Altum

Integrated Micasense Altum in BLG400.

Extras:

- Calibration Panel

x 1

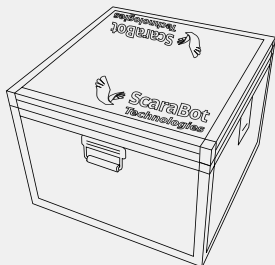

ScaraBot Transport Box

Place for :

- ScaraBot Endurance aircraft Body
- 4 x Smart Batteries
- ScaraBot remote control
- BLG400 Gimbal

x 1

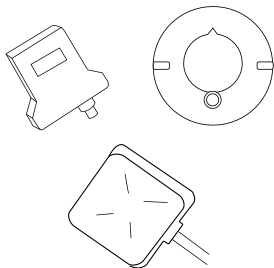

RTK Base Station

BLG 400 with Payload integrated.

Extras:

- Micasense Altum
- DLS2 Light Sensor

x 1

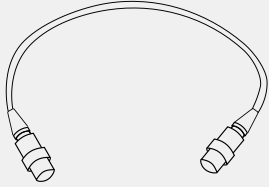

Payload Cable

Lemo Cable for connecting the ScaraBot Controller to the Payload.

x 1

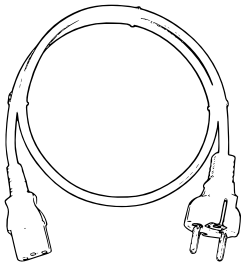

Power Cable

Power cable to supply the ScaraBot Smart Charger

x 1

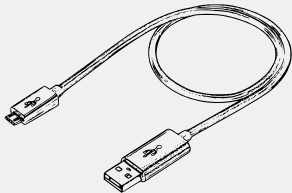

USB Cable

Integrated Micasense Altum in BLG400.

Extras:

- Calibration Panel

x 1

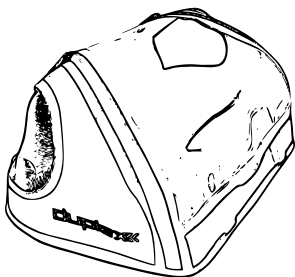

Windshield for Remote Control

Protection against adverse wetter conditions for the Remote control and user.

x 1